



Priority 3 – Toilet Rooms		Comments	Possible Solutions
108	If toilet rooms are available to the public, is at least one toilet room accessible? (Either one for each sex, or one unisex.)	<input type="checkbox"/> Yes <input type="checkbox"/> No	<ul style="list-style-type: none"> <li>• Reconfigure toilet rooms</li> <li>• Combine toilet rooms to create one unisex accessible toilet room</li> </ul>
109	Are there signs at inaccessible toilet rooms that give directions to accessible toilet rooms? [See 2010 ADA Standards for Accessible Design – 216.8]	<input type="checkbox"/> Yes <input type="checkbox"/> No 	<ul style="list-style-type: none"> <li>• Install signs</li> <li>•</li> <li>•</li> </ul>
110	If not all toilet rooms are accessible, is there a sign at the accessible toilet room with the International Symbol of Accessibility? [216.8]	<input type="checkbox"/> Yes <input type="checkbox"/> No 	<ul style="list-style-type: none"> <li>• Install sign</li> <li>•</li> <li>•</li> </ul>
<b>Accessible Route</b>			
111	Is there an accessible route to the accessible toilet room? [206.2.4]	<input type="checkbox"/> Yes <input type="checkbox"/> No	<ul style="list-style-type: none"> <li>• Alter route</li> <li>•</li> <li>•</li> </ul>
<b>Signs at Toilet Rooms</b>			
112	Do text characters contrast with their backgrounds? [703.5]	<input type="checkbox"/> Yes <input type="checkbox"/> No	<ul style="list-style-type: none"> <li>• Install tactile sign</li> <li>• Relocate sign</li> <li>•</li> </ul>
	Are text characters raised?	<input type="checkbox"/> Yes <input type="checkbox"/> No	

[703.2]

Is there Braille?

Yes  No

[703.3]

Is the sign mounted:  
On the wall on the latch side of  
the door?

Yes  No

[703.4.2]

Note: Signs are permitted on  
the push side of doors with  
closers and without hold-open  
devices.

With clear floor space beyond  
the arc of the door swing  
between the closed position  
and 45-degree open position,  
at least 18 x 18 inches centered  
on the tactile characters? \*

Yes  No

Measurement:

So the baseline of the lowest  
character is at least 48 inches  
above the floor and the  
baseline of the highest  
character is no more than 60  
inches above the floor? \*

Yes  No

Measurement:

Note: If the sign is at double  
doors with one active leaf, the  
sign should be on the inactive  
leaf; if both leaves are active,  
the sign should be on the wall  
to the right of the right leaf.

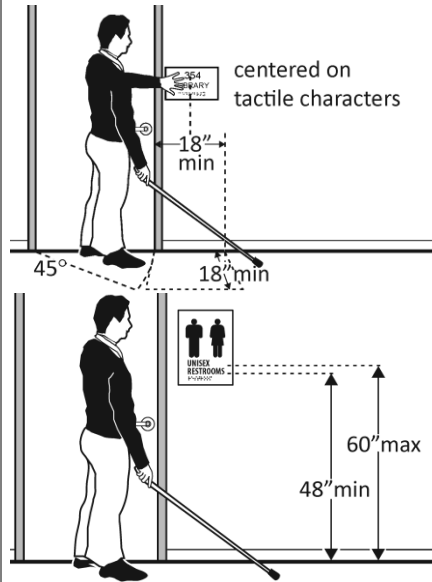
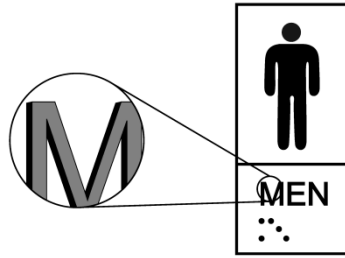

Photo #:

\*If constructed before  
3/15/2012 and a person  
may approach within 3  
inches of the sign without  
encountering protruding  
objects or standing within  
the door swing, relocation  
not required

\*If constructed before  
3/15/2012 and mounted  
no higher than 60 inches  
to the centerline of the  
sign, relocation is not  
required

**Entrance**

**113** If there is a privacy wall and the door swings out, is there at least 24 inches of maneuvering clearance beyond the door latch side and 42 inches to the privacy wall?  
[404.2.4]

Yes  No

Measurement:

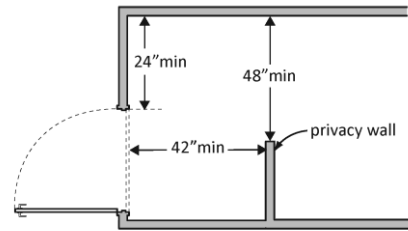

Photo #:

- Reconfigure space
- 
- 

**114** If there is a privacy wall and the door swings in, is there at least 24 inches of maneuvering clearance beyond the door latch side and at least 48 inches to the privacy wall if there is no door closer or at least 54 inches if there is a door closer?  
[404.2.4]

Yes  No

Measurement:

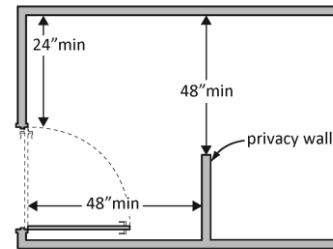

Photo #:

- Reconfigure space
- 
- 

**In the Toilet Room**

**115** Is there a clear path to at least one of each type of fixture, e.g. lavatory, hand dryer, etc., that is at least 36 inches wide?  
[403.5.1]

Yes  No

Measurement:



Photo #:

- Remove obstructions
- 
-

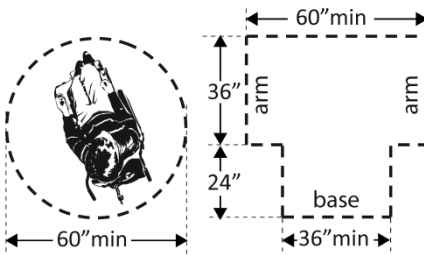
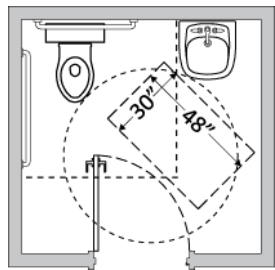
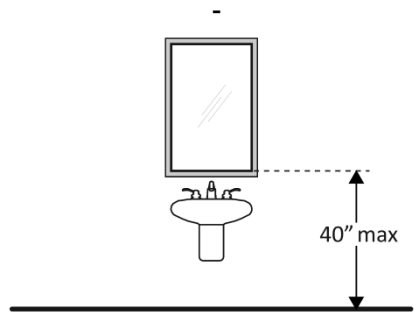
<p><b>116</b> Is there clear floor space available for a person in a wheelchair to turn around, i.e. a circle at least 60 inches in diameter or a T-shaped space within a 60-inch square? [603.2.1]</p>	<p><input type="checkbox"/> Yes <input type="checkbox"/> No</p> <p>Measurement:</p>	 <p>The diagram shows a wheelchair inside a dashed circle with a diameter of 60 inches. To the right, a T-shaped clear floor space is shown within a 60-inch square. The T-shape has a vertical 'arm' that is 36 inches wide and 24 inches high, and a horizontal 'base' that is 36 inches wide. The total width of the square is 60 inches.</p>	<p>Photo #:</p>	<ul style="list-style-type: none"> <li>• Move or remove partitions, fixtures or objects such as trash cans</li> <li>•</li> <li>•</li> </ul>
<p><b>117</b> In a single user toilet room if the door swings in and over a clear floor space at an accessible fixture, is there a clear floor space at least 30 x 48 inches beyond the swing of the door? [603.2.3 Exception 2]</p>	<p><input type="checkbox"/> Yes <input type="checkbox"/> No</p> <p>Measurement:</p>	 <p>The diagram shows a top-down view of a toilet room with a door swinging inward. A dashed circle and a dashed rectangle are drawn to indicate the required clear floor space. The circle has a diameter of 30 inches, and the rectangle has dimensions of 30 inches by 48 inches, extending beyond the door's swing.</p>	<p>Photo #:</p>	<ul style="list-style-type: none"> <li>• Reverse door swing</li> <li>• Alter toilet room</li> <li>•</li> </ul>
<p><b>118</b> If the mirror is over a lavatory or countertop, is the bottom edge of the reflecting surface no higher than 40 inches above the floor?</p> <p>Or</p> <p>If the mirror is not over the lavatory or countertop, is the bottom edge of the reflecting surface no higher than 35 inches above the floor?*</p> <p>[603.3]</p>	<p><input type="checkbox"/> Yes <input type="checkbox"/> No</p> <p>Measurement:</p> <p><input type="checkbox"/> Yes <input type="checkbox"/> No</p> <p>Measurement:</p>	 <p>The diagram shows a mirror mounted on a wall above a lavatory. A horizontal dashed line extends from the bottom edge of the mirror to a vertical dimension line that measures the height from the floor to the bottom edge of the mirror. The measurement is labeled as 40" max.</p>	<p>Photo #:</p>	<p>* If installed before 3/15/2012 and the bottom edge of the reflecting surface is no higher than 40 inches above the floor, lowering the mirror to 35 inches is not required</p> <ul style="list-style-type: none"> <li>• Lower the mirror</li> <li>• Add another mirror</li> <li>•</li> </ul>

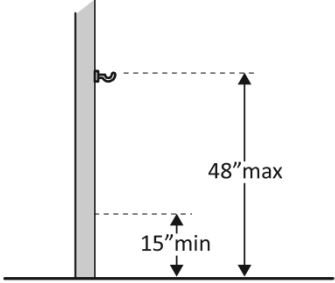
<p><b>119</b> If there is a coat hook, is it no less than 15 inches and no greater than 48 inches above the floor?*</p> <p>[603.4]</p>	<p><input type="checkbox"/> Yes <input type="checkbox"/> No</p> <p>Measurement:</p>		<p>Photo #:</p>	<ul style="list-style-type: none"> <li>• Adjust hook</li> <li>• Replace with or provide additional accessible hook</li> <li>•</li> </ul> <p>* If installed before 3/15/2010 and the clear floor space allows a parallel approach, the coat hook may be 54 inches above the floor.</p>
--	---	--	-----------------	---

**Lavatories** The 2010 Standards refer to sinks in toilet rooms as lavatories.

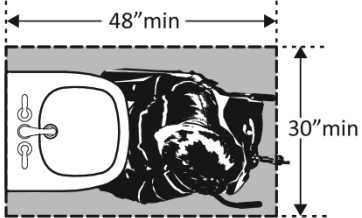
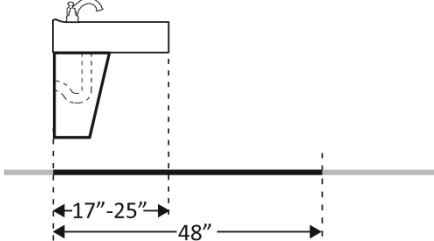
<p><b>120</b> Does at least one lavatory have a clear floor space for a forward approach at least 30 inches wide and 48 inches long?</p> <p>[606.2]</p>	<p><input type="checkbox"/> Yes <input type="checkbox"/> No</p> <p>Measurement:</p>		<p>Photo #:</p>	<ul style="list-style-type: none"> <li>• Alter lavatory</li> <li>• Replace lavatory</li> <li>•</li> </ul>
<p><b>121</b> Do no less than 17 inches and no greater than 25 inches of the clear floor space extend under the lavatory so that a person using a wheelchair can get close enough to reach the faucet?</p> <p>[306.2]</p>	<p><input type="checkbox"/> Yes <input type="checkbox"/> No</p> <p>Measurement:</p>		<p>Photo #:</p>	<ul style="list-style-type: none"> <li>• Alter lavatory</li> <li>• Replace lavatory</li> <li>•</li> </ul>

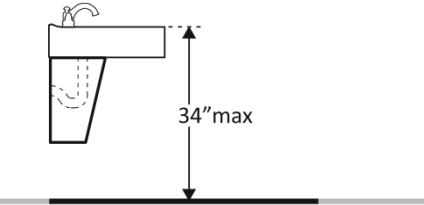
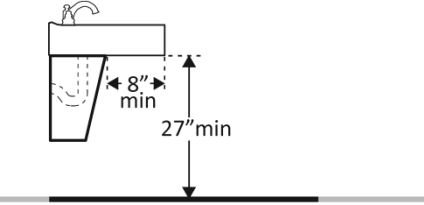
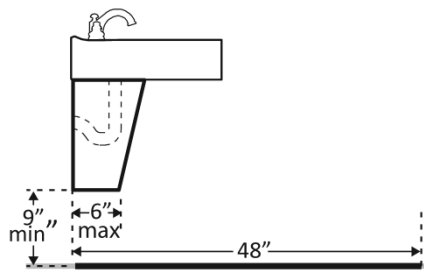
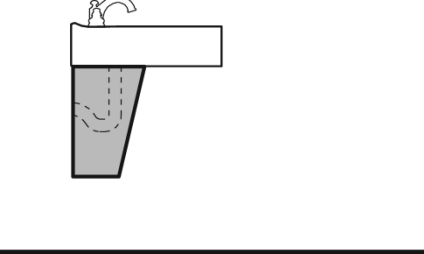
<p><b>122</b> Is the front of the lavatory or counter surface, whichever is higher, no more than 34 inches above the floor? [606.3]</p>	<p><input type="checkbox"/> Yes <input type="checkbox"/> No</p> <p>Measurement:</p>		<p>Photo #:</p>	<ul style="list-style-type: none"> <li>• Alter lavatory</li> <li>• Replace lavatory</li> <li>•</li> </ul>
<p><b>123</b> Is there at least 27 inches clearance from the floor to the bottom of the lavatory that extends at least 8 inches under the lavatory for knee clearance? [306.3.3]</p>	<p><input type="checkbox"/> Yes <input type="checkbox"/> No</p> <p>Measurement:</p>		<p>Photo #:</p>	<ul style="list-style-type: none"> <li>• Alter lavatory</li> <li>• Replace lavatory</li> <li>•</li> </ul>
<p><b>124</b> Is there toe clearance at least 9 inches high? [306.3.3]</p> <p>Note: Space extending greater than 6 inches beyond the available toe clearance at 9 inches above the floor is not considered toe clearance.</p>	<p><input type="checkbox"/> Yes <input type="checkbox"/> No</p>		<p>Photo #:</p>	<ul style="list-style-type: none"> <li>• Alter lavatory</li> <li>• Replace lavatory</li> <li>•</li> </ul>
<p><b>125</b> Are pipes below the lavatory insulated or otherwise configured to protect against contact? [606.5]</p>	<p><input type="checkbox"/> Yes <input type="checkbox"/> No</p>		<p>Photo #:</p>	<ul style="list-style-type: none"> <li>• Install insulation</li> <li>• Install cover panel</li> <li>•</li> </ul>

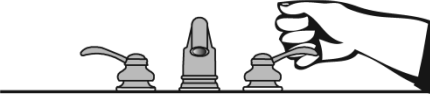
<p><b>126</b> Can the faucet be operated without tight grasping, pinching, or twisting of the wrist?</p> <p>Is the force required to activate the faucet no greater than 5 pounds? [606.4]</p>	<p><input type="checkbox"/> Yes <input type="checkbox"/> No</p> <p><input type="checkbox"/> Yes <input type="checkbox"/> No</p>		<p>Photo #:</p>	<ul style="list-style-type: none"> <li>• Adjust faucet</li> <li>• Replace faucet</li> <li>•</li> </ul>
--	---	--	-----------------	--

**Soap Dispensers and Hand Dryers**

<p><b>127</b> Are the operable parts of the soap dispenser within one of the following reach ranges:</p> <p>Above lavatories or counters no less than 20 inches and no greater than 25 inches deep: no higher than 44 inches above the floor? [308.2.2]</p> <p>Above lavatories less than 20 inches deep: no higher than 48 inches above the floor?</p> <p>Not over an obstruction: no higher than 48 inches above the floor? [308.2]</p>	<p><input type="checkbox"/> Yes <input type="checkbox"/> No</p> <p>Measurement:</p> <p><input type="checkbox"/> Yes <input type="checkbox"/> No</p> <p>Measurement:</p> <p><input type="checkbox"/> Yes <input type="checkbox"/> No</p> <p>Measurement:</p>		<p>Photo #:</p>	<ul style="list-style-type: none"> <li>• Adjust dispensers</li> <li>• Replace with or provide additional accessible dispensers</li> <li>•</li> </ul>
---	---	---	-----------------	--

Photo #:

**128** Are the operable parts of the hand dryer or towel dispenser within one of the following reach ranges:

Above lavatories or counters no less than 20 inches and no greater than 25 inches deep: no higher than 44 inches above the floor?

Yes  No

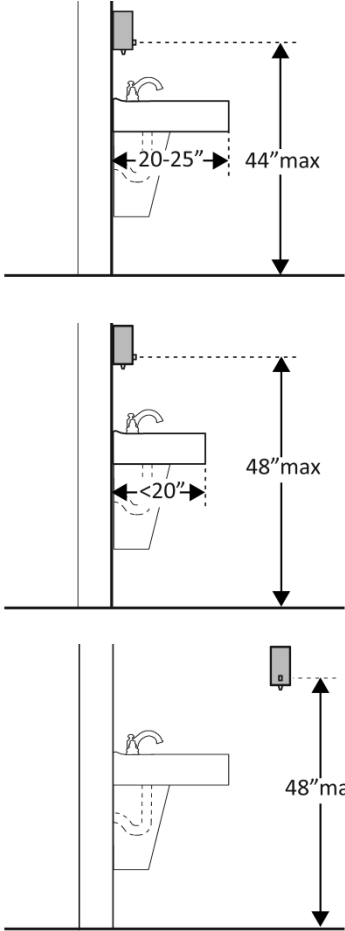
Measurement:

Above lavatories less than 20 inches deep: no higher than 48 inches above the floor?

Yes  No

Measurement:

Not over an obstruction: no higher than 48 inches above the floor?  
[308.2]

Yes  No

Measurement:

Can the operable parts of the hand dryer or towel dispenser be operated without tight grasping, pinching or twisting of the wrist?

Yes  No

Is the force required to activate the hand dryer or towel dispenser no greater than 5 pounds?

Yes  No

Measurement:

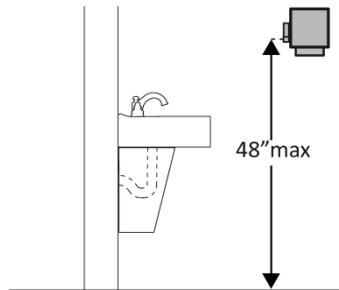
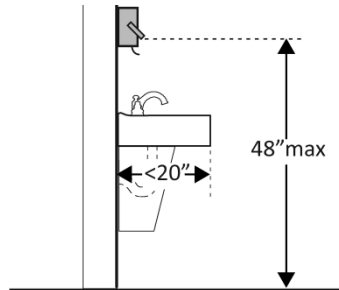
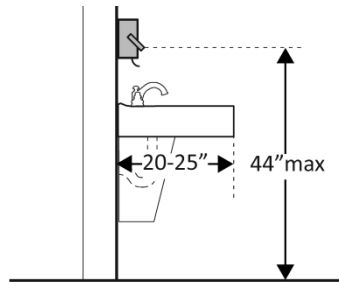

- Adjust dispensers
- Replace with or provide additional accessible dispensers
-



[309.4]			Photo #:	
---------	--	--	----------	--

**Water Closets in Single-User Toilet Rooms and Compartments (Stalls)** The 2010 Standards refer to toilets as water closets.

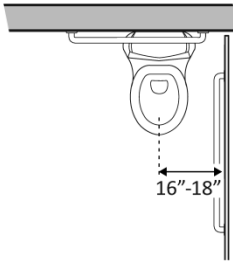
<p><b>129</b> Is the centerline of the water closet no less than 16 inches and no greater than 18 inches from the side wall or partition? [604.2]</p>	<p><input type="checkbox"/> Yes <input type="checkbox"/> No</p> <p>Measurement:</p>		Photo #:	<ul style="list-style-type: none"> <li>• Move toilet</li> <li>• Replace toilet</li> <li>• Move partition</li> <li>•</li> </ul>
---	---	--	----------	--

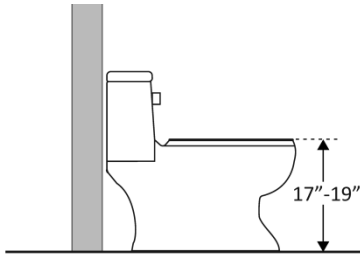
<p><b>130</b> Is the height of the water closet no less than 17 inches and no greater than 19 inches above the floor measured to the top of the seat? [604.4]</p>	<p><input type="checkbox"/> Yes <input type="checkbox"/> No</p> <p>Measurement:</p>		Photo #:	<ul style="list-style-type: none"> <li>• Adjust toilet height</li> <li>• Replace toilet</li> <li>•</li> </ul>
---	---	---	----------	---

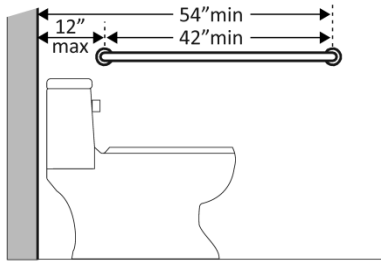
<p><b>131</b> Is there a grab bar at least 42 inches long on the side wall?</p> <p>Is it located no more than 12 inches from the rear wall?</p> <p>Does it extend at least 54 inches from the rear wall?</p>	<p><input type="checkbox"/> Yes <input type="checkbox"/> No</p> <p>Measurement:</p> <p><input type="checkbox"/> Yes <input type="checkbox"/> No</p> <p>Measurement:</p> <p><input type="checkbox"/> Yes <input type="checkbox"/> No</p> <p>Measurement:</p>		Photo #:	<ul style="list-style-type: none"> <li>• Install grab bar</li> <li>• Relocate grab bar</li> <li>• Relocate objects</li> <li>•</li> </ul>
--	---	--	----------	--

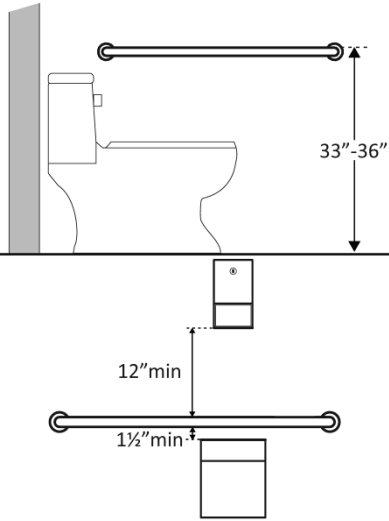
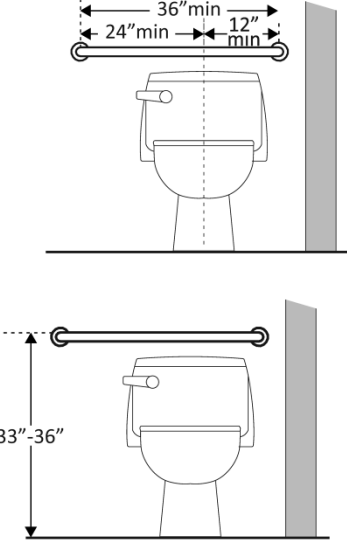
<p>[604.5.1]</p> <p>Is it mounted no less than 33 inches and no greater than 36 inches above the floor to the top of the gripping surface? [609.4]</p> <p>Is there at least 12 inches clearance between the grab bar and protruding objects above?*</p> <p>Is there at least 1½ inches clearance between the grab bar and projecting objects below?*</p> <p>Is the space between the wall and the grab bar 1 ½ inches? [609.3]</p>	<p><input type="checkbox"/> Yes <input type="checkbox"/> No Measurement:</p> <p><input type="checkbox"/> Yes <input type="checkbox"/> No Measurement:</p> <p><input type="checkbox"/> Yes <input type="checkbox"/> No Measurement:</p> <p><input type="checkbox"/> Yes <input type="checkbox"/> No Measurement:</p>		<p>Photo #:</p>	<p>* If constructed before 3/15/2012 grab bars do not need to be relocated; there are no space requirements above and below grab bars in the 1991 Standards</p>
<p><b>132</b> Is there a grab bar at least 36 inches long on the rear wall?</p> <p>Does it extend at least 12 inches from the centerline of the water closet on one side (side wall)?</p> <p>Does it extend at least 24 inches on the other (open) side? [604.5.2]</p> <p>Is it mounted no less than 33 inches and no greater than 36</p>	<p><input type="checkbox"/> Yes <input type="checkbox"/> No Measurement:</p> <p><input type="checkbox"/> Yes <input type="checkbox"/> No Measurement:</p> <p><input type="checkbox"/> Yes <input type="checkbox"/> No Measurement:</p> <p><input type="checkbox"/> Yes <input type="checkbox"/> No Measurement:</p>		<p>Photo #:</p>	<ul style="list-style-type: none"> <li>• Install grab bar</li> <li>• Relocate grab bar</li> <li>• Relocate objects</li> <li>•</li> </ul>

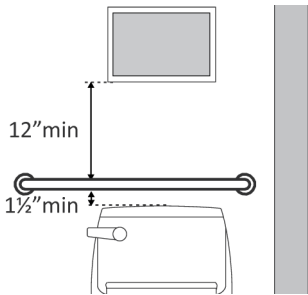
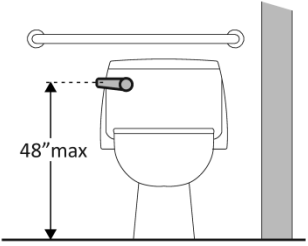
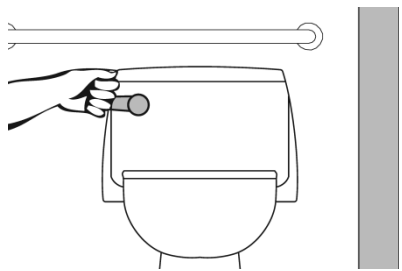
<p>inches above the floor to the top of the gripping surface? [609.4]</p> <p>Are there at least 12 inches clearance between the grab bar and protruding objects above?*</p> <p>Are there at least 1½ inches clearance between the grab bar and projecting objects below?*</p> <p>Is the space between the wall and the grab bar 1½ inches? [609.3]</p>	<p><input type="checkbox"/> Yes <input type="checkbox"/> No Measurement:</p> <p><input type="checkbox"/> Yes <input type="checkbox"/> No Measurement:</p> <p><input type="checkbox"/> Yes <input type="checkbox"/> No Measurement:</p>		<p>Photo #:</p>	<p>* If constructed before 3/15/2012 grab bars do not need to be relocated; there are no space requirements above and below grab bars in the 1991 Standards</p>
<p><b>133</b> If the flush control is hand operated, is the operable part located no higher than 48 inches above the floor? [604.6]</p>	<p><input type="checkbox"/> Yes <input type="checkbox"/> No Measurement:</p>		<p>Photo #:</p>	<ul style="list-style-type: none"> <li>• Move control</li> <li>• Install sensor with override button no higher than 48 inches</li> <li>•</li> </ul>
<p><b>134</b> If the flush control is hand operated, can it be operated with one hand and without tight grasping, pinching, or twisting of the wrist?</p> <p>Is the force required to activate the flush control no greater than 5 pounds? [605.4]</p>	<p><input type="checkbox"/> Yes <input type="checkbox"/> No Measurement:</p>		<p>Photo #:</p>	<ul style="list-style-type: none"> <li>• Change control</li> <li>• Adjust control</li> <li>•</li> </ul>

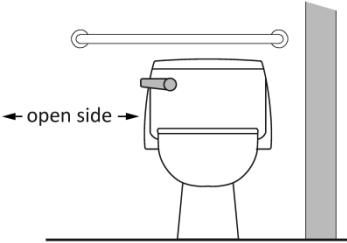
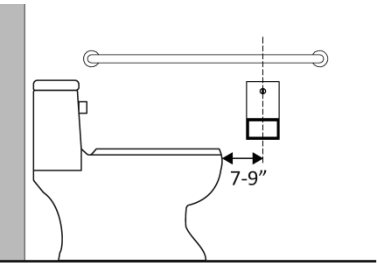
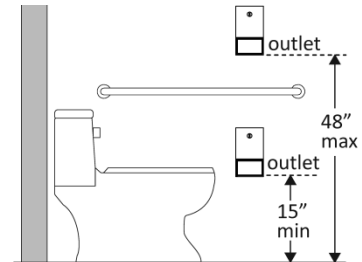
<p><b>135</b> Is the flush control on the open side of the water closet? [604.6]</p>	<p><input type="checkbox"/> Yes <input type="checkbox"/> No</p>		<p>Photo #:</p>	<ul style="list-style-type: none"> <li>• Move control</li> <li>•</li> <li>•</li> </ul>
<p><b>136</b> Is the toilet paper dispenser located no less than 7 inches and no greater than 9 inches from the front of the water closet to the centerline of the dispenser?*</p> <p>[604.7]</p>	<p><input type="checkbox"/> Yes <input type="checkbox"/> No</p> <p>Measurement:</p>		<p>Photo #:</p>	<p>* If constructed before 3/15/2012 dispenser does not need to be relocated if it is within reach from the water closet seat; the 1991 Standards do not specify distance from the front of the water closet</p> <ul style="list-style-type: none"> <li>• Relocate dispenser</li> <li>•</li> <li>•</li> </ul>
<p><b>137</b> Is the outlet of the dispenser:</p> <p>Located no less than 15 inches and no greater than 48 inches above the floor?</p> <p>Not located behind grab bars?</p> <p>[604.7]</p>	<p><input type="checkbox"/> Yes <input type="checkbox"/> No</p> <p>Measurement:</p> <p><input type="checkbox"/> Yes <input type="checkbox"/> No</p>		<p>Photo #:</p>	<ul style="list-style-type: none"> <li>• Relocate dispenser</li> <li>•</li> <li>•</li> </ul>

**138** Does the dispenser allow continuous paper flow?  
[604.7]

Yes  No

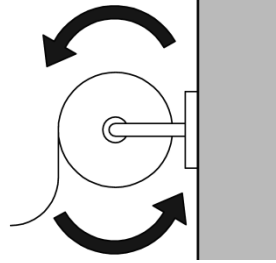

Photo #:

- Adjust dispenser
- Replace dispenser
-